

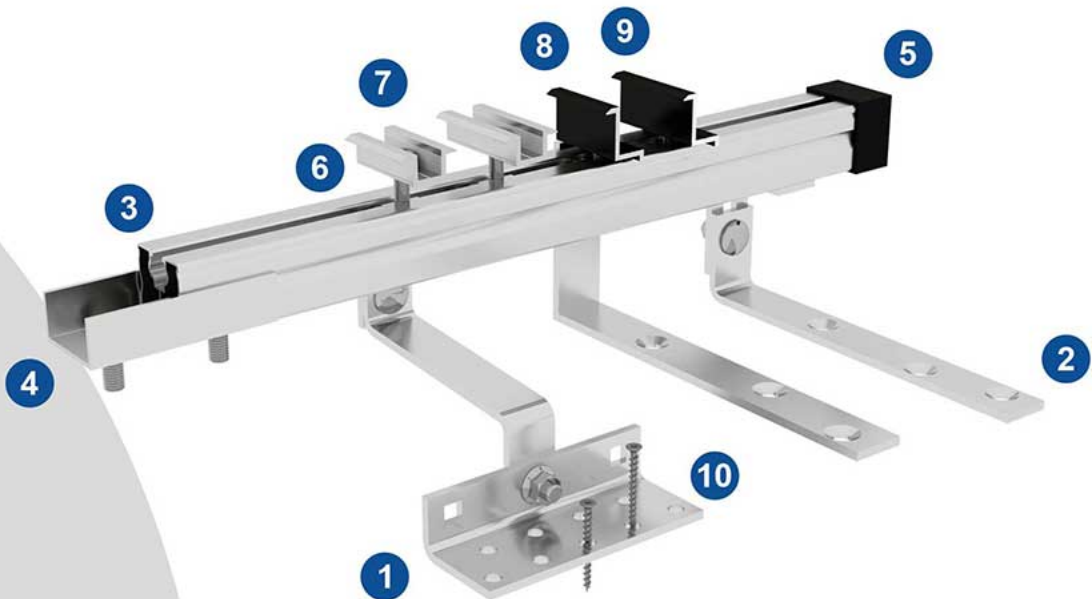

H TYPE TILED&TRAPEZE ROOF MOUNTING



TILED ROOF H TYPE MOUNTING



C1272
0.751 kg /m

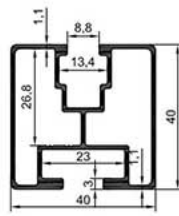

C1273
0.793 kg /m

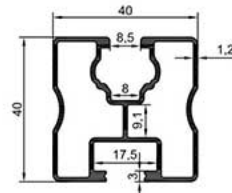



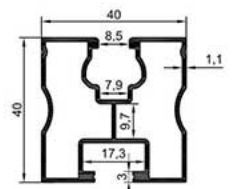









C1564
0.813 kg/m



C1585
0.743 kg/m

COMPONENTS

	IMAGE	PRODUCT CODE	PRODUCT
1		ALS1011	DOUBLE ADJUSTABLE STEEL HOOK
2		ALS1014	SLATE HOOK
3		ALS1001	H-PROFILE
4		ALS1005	CONNECTOR FOR H PROFILE
5		ALS1009	END CAP
6		ALS1032	SPRING NUT
7		ALS1021	MIDDLE CLAMP
8		ALS1017	END CLAMP 30MM
9		ALS1019	END CLAMP 35MM
9		ALS1034	M8 35 BOLT
10		ALS1040	6*80 ROOF SCREW
11		ALS1037	M10X25
12		ALS1038	KNURLED NUT M10

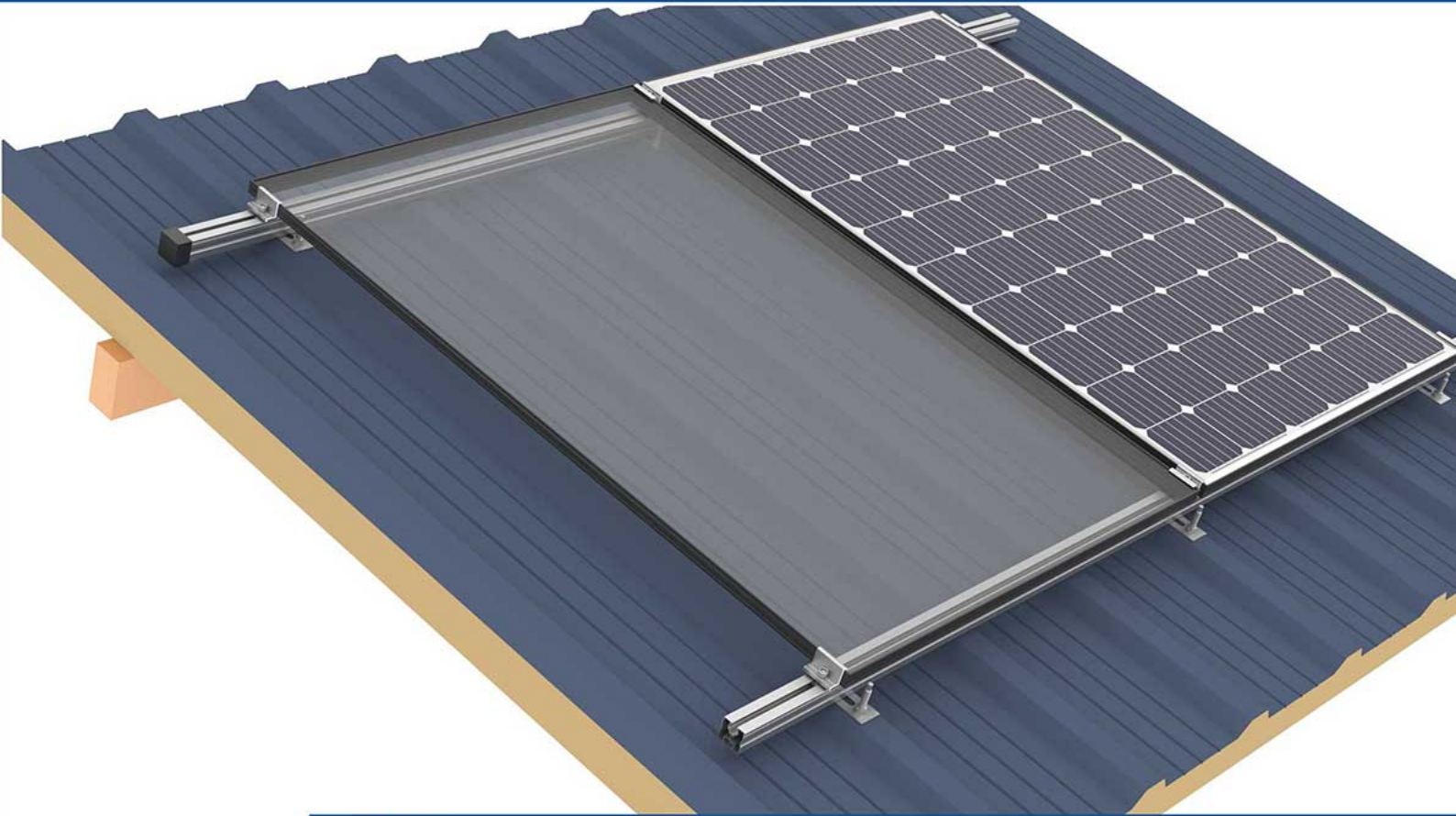

TRAPEZE ROOF H TYPE MOUNTING

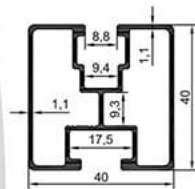
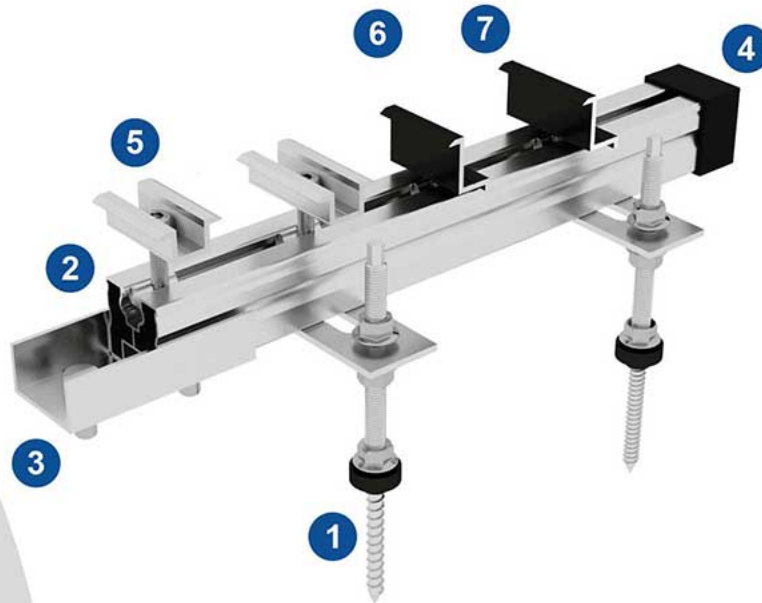

C1272
0.751 kg / m

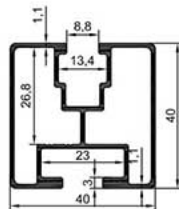

C1273
0.793 kg / m

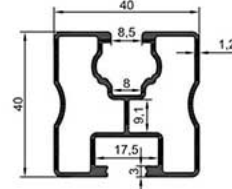



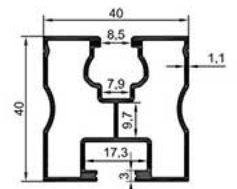







C1564
0.813 kg / m



C1585
0.743 kg / m

COMPONENTS

	IMAGE	PRODUCT CODE	PRODUCT
1		ALS1013	STICK SCREW
2		ALS1001	H-PROFILE
3		ALS1003	CONNECTOR FOR H PROFILE
4		ALS1009	END CAP
5		ALS1021	MIDDLE CLAMP
6		ALS1017	END CLAMP 30MM
7		ALS1019	END CLAMP 35MM
8		ALS1032	SPRING NUT
9		ALS1034	M8 35 BOLT
10		ALS1037	M10X25
11		ALS1038	KNURLED NUT M10



Front Trade Metal Sanayi Ltd.Şti.
Barbaros Hayrettin Paşa Mah. 1995 Sk. No:1/3
AKROS K:18 D:364 34522 Esenyurt / İstanbul
Gsm: +90 543 189 23 23
E-mail: info@frontmetal.com.tr

www.frontmetalsolar.com