

FLS 100

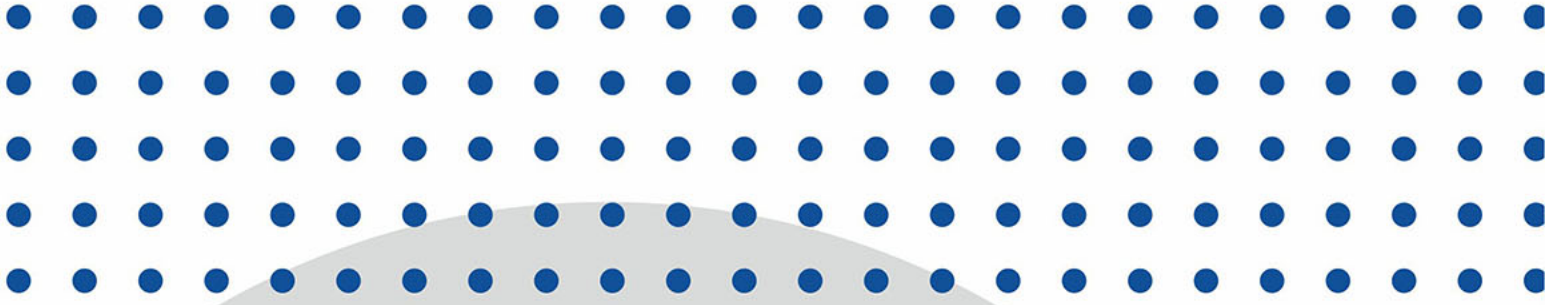

Mimari it Sistemi

Architectural Fence
Systems



Sipariř Katalođu / Order Catalog



Sipariř Katalođu / Order Catalog

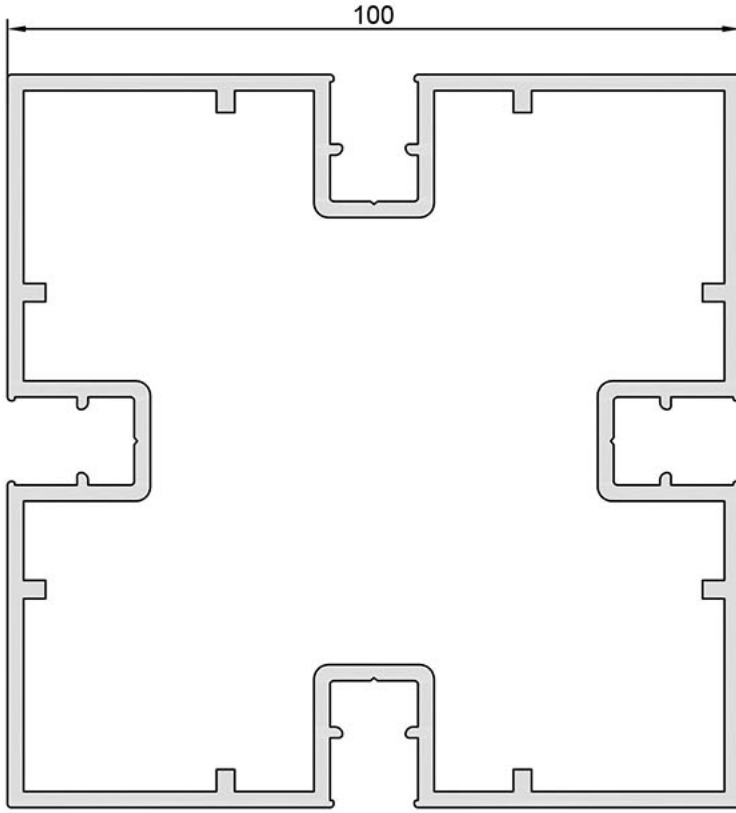

22-6962
100 mm DİKEY PROFİL
Ağırlık / Weight = 3,366 kg/m

ÖLÇEK : 1/1

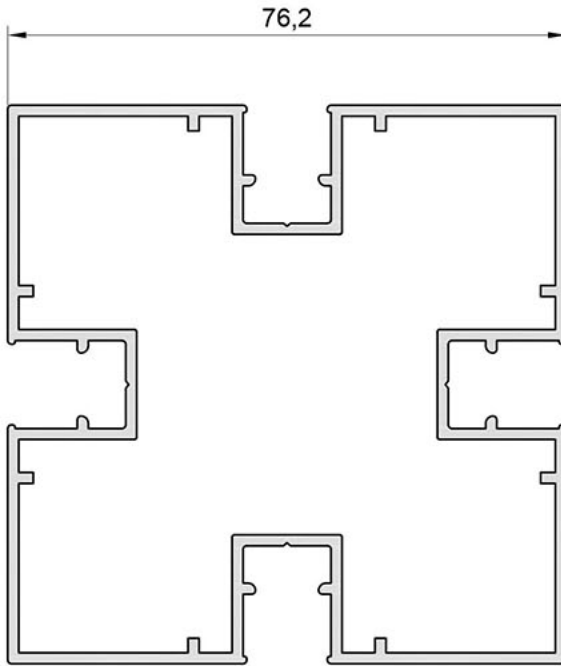

22-6963
76 mm DİKEY PROFİL
Ağırlık / Weight = 1,864 kg/m

ÖLÇEK : 1/1

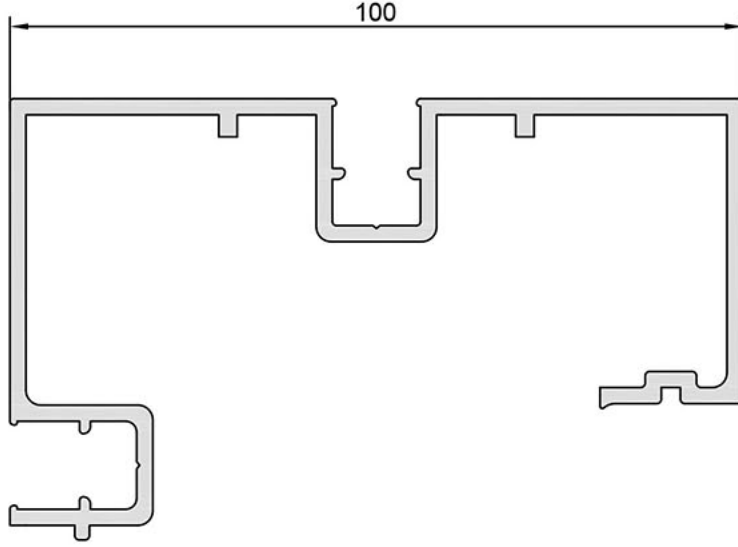

23-7189
100 mm Panel PROFİL
Ağırlık / Weight = 1,787 kg/m

ÖLÇEK : 1/1

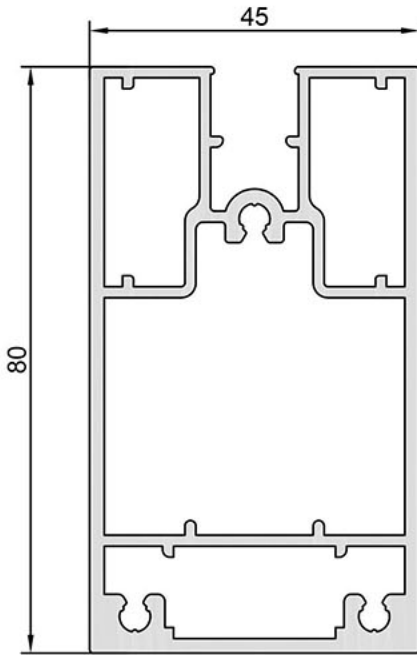

23-7113
KAPI PROFİLİ
Ağırlık / Weight = 2,094 kg/m ÖLÇEK : 1/1

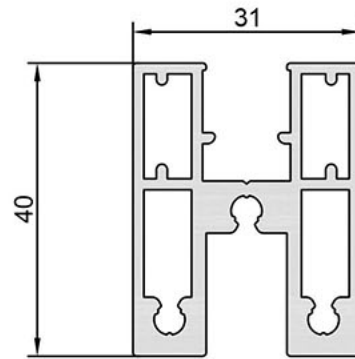

23-7140
* TRABZAN PROFİLİ
Ağırlık / Weight = 1,223 kg/m

ÖLÇEK : 1/1

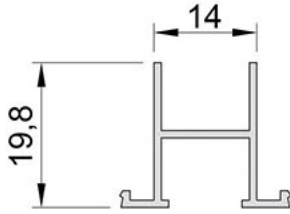

07-2725

PN 06

Ağırlık / Weight = 0,176 kg/m

ÖLÇEK : 1/1

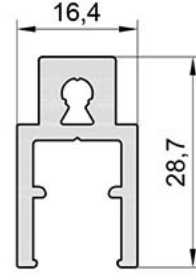

23-7114

ADAPTÖR PROFİLİ

Ağırlık / Weight = 0,523 kg/m

ÖLÇEK : 1/1

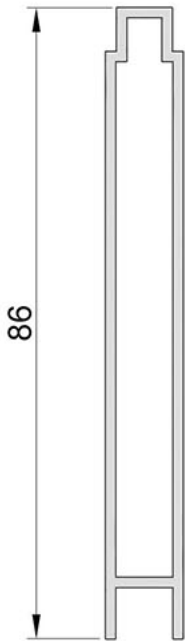

99-1209

LAMBRİ PROFİLİ

Ağırlık / Weight = 0,661 kg/m ÖLÇEK : 1/1

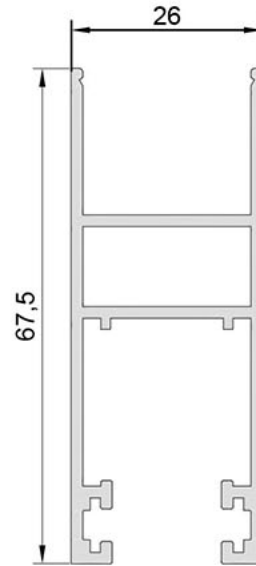

99-1228

PN 02

Ağırlık / Weight = 0,851 kg/m

Biçilerek kullanılacaktır. ÖLÇEK : 1/1

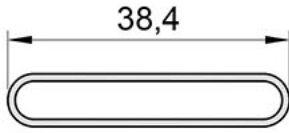

07 -2724

PN 05

Ağırlık / Weight = 0,222 kg/m

ÖLÇEK : 1/1



22-6964

KAPAK PROFİLİ

Ağırlık / Weight = 0,110 kg/m

ÖLÇEK : 1/1

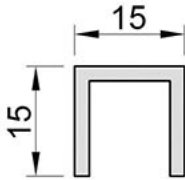

00-1362

U TRABZAN

Ağırlık / Weight = 0,222 kg/m

ÖLÇEK : 1/2

ÖLÇEK : 1/1

Aksesuar Listesi List of Accessories

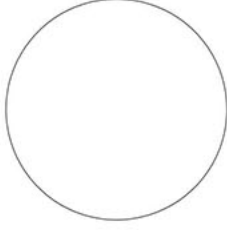

Ö : 1/2



PN 05 SOKET SAĞ

Aksesuar Kod Accessories Code	
	Adet
PN D 01	50

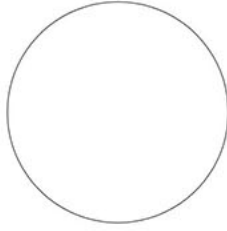

Ö : 1/2



PN 05 SOKET SOL

Aksesuar Kod Accessories Code	
	Adet
PN D 02	50

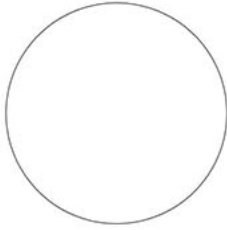

Ö : 1/2

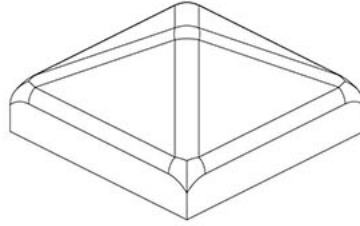

100 mm DİKEY PROFİL
ÜST KAPAK

Aksesuar Kod Accessories Code	
	Adet
TT03 011	1

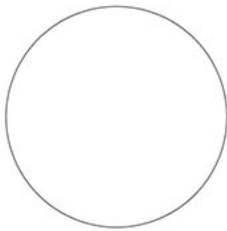

Ö : 1/2

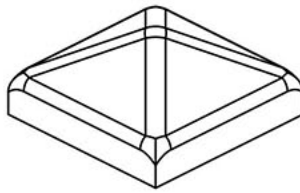

76 mm DİKEY PROFİL
ÜST KAPAK

Aksesuar Kod Accessories Code	
	Adet
TT03 012	1

FLS 100

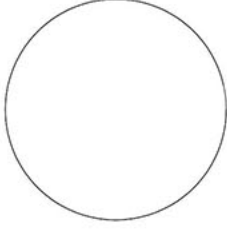

Ö : 1/2

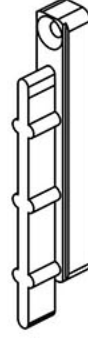

LAMBRI SOKET

Aksesuar Listesi List of Accessories

Aksesuar Kod Accessories Code	
	Adet
AT 03 045	1

Not:*1 İlgili ürün temin süreleri standart temin süreleri dışında olup temasa geçilmesi önem taşımaktadır.

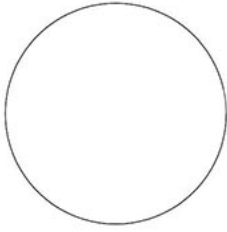

Ö : 1/2

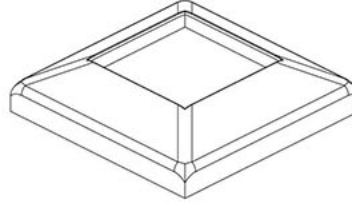

100 mm DİKEY PROFİL
ALT KAPAK

Aksesuar Kod Accessories Code	
	Adet
TT03 013	1

Not:*1 İlgili ürün temin süreleri standart temin süreleri dışında olup temasa geçilmesi önem taşımaktadır.

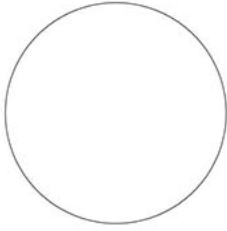

Ö : 1/2

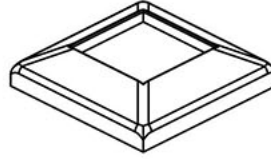

76 mm DİKEY PROFİL
ALT KAPAK

Aksesuar Kod Accessories Code	
	Adet
TT03 014	1

Not:*1 İlgili ürün temin süreleri standart temin süreleri dışında olup temasa geçilmesi önem taşımaktadır.

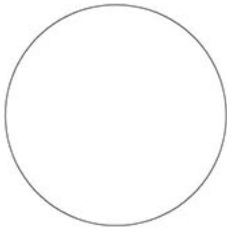

Ö : 1/2

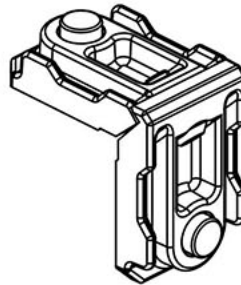

Pimli Köşe Takoðu
Corner Joint with Pin

Aksesuar Kod Accessories Code	
PN D 0333	

Aksesuar Listesi
List of Accessories

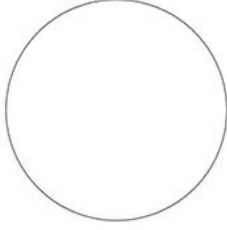

Ö : 1/1

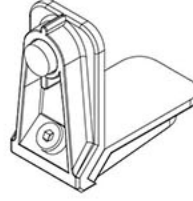

Pimli Köşe Takoza
Corner Joint with
Pin

Aksesuar Kod Accessories Code	
	Adet
G01 061	10

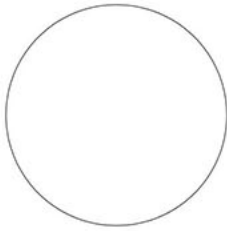

Ö : 1/1

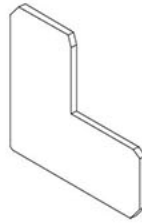

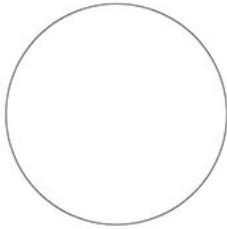

Köşe Gönyesi
Mitre Joint Angle

Aksesuar Kod Accessories Code	
	Adet
G01 002	

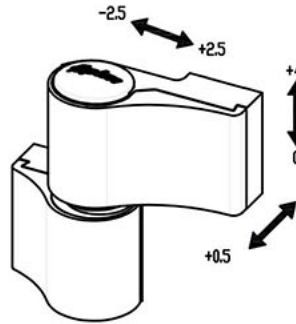

Ö : 1/1



Aksesuar Kod Accessories Code	
	m
MT01 014	

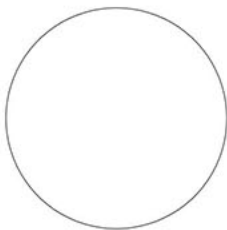

Ö : 1/1

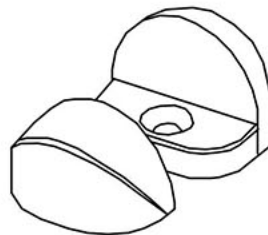

STOPER

Aksesuar Kod Accessories Code	
	m
A03 322	

FLS 100

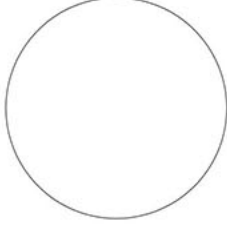

Ö : 1/1

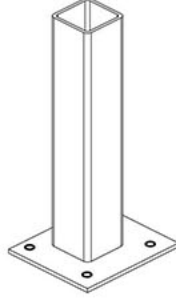

ANKRAJ
22-6962 kodlu profil için

Aksesuar Listesi List of Accessories

Aksesuar Kod Accessories Code	
	Adet
HT01 024	500 mm
HT01 025	900 mm
HT01 027	700 mm

Ankraj seçimi için statik diyagramına bakınız

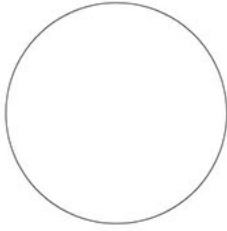

Ö : 1/1

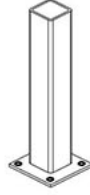

ANKRAJ
22-6963 kodlu profil için

Aksesuar Kod Accessories Code	
	Adet
HT01 028	500 mm
HT01 029	700 mm
HT01 030	900 mm

Ankraj seçimi için statik diyagramına bakınız

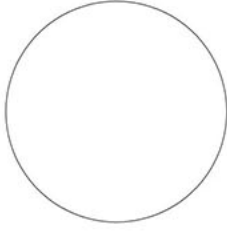

Ö : 1/1



ANKRAJ
22-6962 kodlu profil için

Aksesuar Kod Accessories Code	
	m
HT01 026	

Ankraj seçimi için statik diyagramına bakınız

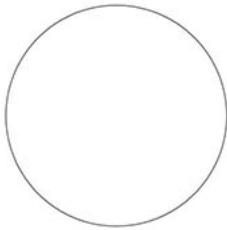

Ö : 1/1



BORU KOL

Aksesuar Kod Accessories Code	
	m
KT03 004	500 mm
KT03 005	700 mm

Aksesuar Listesi List of Accessories

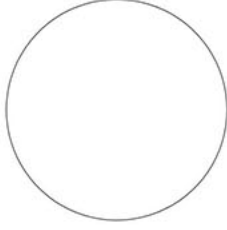

Ö : 1/5

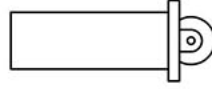

Aksesuar Kod Accessories Code	
	Adet
40 D 7004	-

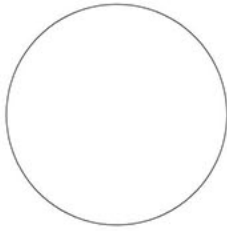

Ö : 1/5

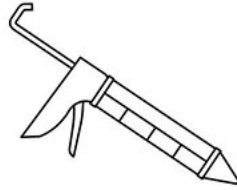

SİLİKON

Aksesuar Kod Accessories Code	
	Adet
D06 008	

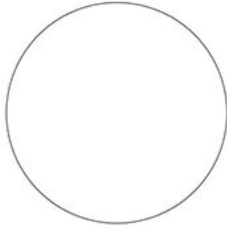

Ö : 1/5

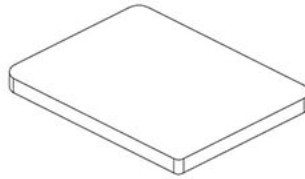

* TRABZAN PROFİL KAPAĞI

Aksesuar Kod Accessories Code	
	Adet
TT03 015	

Not:*1 İlgili ürün temin süreleri standart temin süreleri dışında olup temasa geçilmesi önem taşımaktadır.

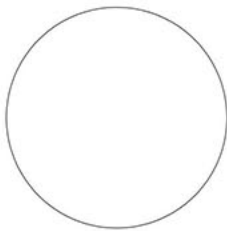

Ö : 1/5

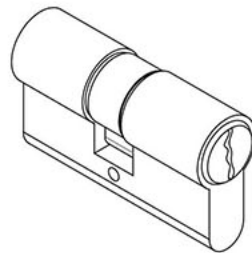

Aksesuar Kod Accessories Code	
	Adet
B01 017	

FLS 100

Aksesuar Listesi List of Accessories

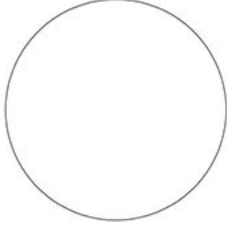

Ö : 1/5

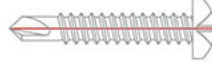

YBS 4,8x25

Aksesuar Kod Accessories Code	
	Adet
V9T 48 25	-

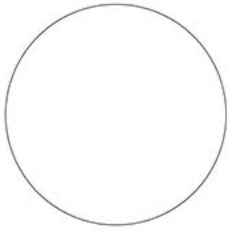

Ö : 1/5

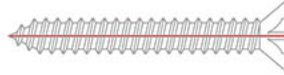

YHB 4,8x38

Aksesuar Kod Accessories Code	
	Adet
V1 48 38	

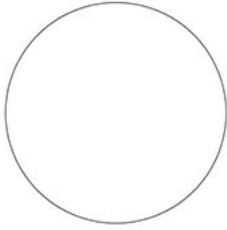

Ö : 1/5

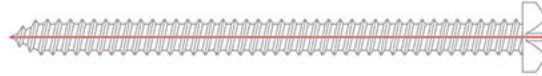

YBS 4,8x70

Aksesuar Kod Accessories Code	
	m

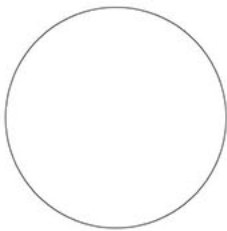

Ö : 1/5



Vida Kapağı (Ø10mm)

Aksesuar Kod Accessories Code	
	m
A03 129	

ANKRAJ SEÇİM TABLOSU

22-6962	YÜKSEKLİK (mm)	60 kg / m ²										
		1800	HT01 024	HT01 024	HT01 027	HT01 027	HT01 027	HT01 027	HT01 027	HT01 025	HT01 025	HT01 025
		1700	HT01 024	HT01 024	HT01 024	HT01 027	HT01 027	HT01 027	HT01 027	HT01 025	HT01 025	HT01 025
		1600	HT01 024	HT01 024	HT01 024	HT01 024	HT01 027	HT01 027	HT01 027	HT01 027	HT01 025	HT01 025
		1500	HT01 024	HT01 024	HT01 024	HT01 024	HT01 024	HT01 024	HT01 027	HT01 027	HT01 027	HT01 027
		1400	HT01 024	HT01 024	HT01 024	HT01 024	HT01 024	HT01 024	HT01 027	HT01 027	HT01 027	HT01 027
		1300	HT01 024	HT01 024	HT01 024	HT01 024	HT01 024	HT01 024	HT01 024	HT01 027	HT01 027	HT01 027
		1200	HT01 024	HT01 024	HT01 024	HT01 024	HT01 024	HT01 024	HT01 024	HT01 024	HT01 024	HT01 024
		1100	HT01 024	HT01 024	HT01 024	HT01 024	HT01 024	HT01 024	HT01 024	HT01 024	HT01 024	HT01 024
			1100	1200	1300	1400	1500	1600	1700	1800	1900	2000
	GENİŞLİK (mm)											
YÜKSEKLİK (mm)	96 kg / m ²											
	1800	HT01 025	HT01 025	HT01 025								
	1700	HT01 025	HT01 025	HT01 025								
	1600	HT01 025	HT01 025	HT01 025	HT01 025							
	1500	HT01 027	HT01 027	HT01 027	HT01 027	HT01 027						
	1400	HT01 027	HT01 027	HT01 027	HT01 027	HT01 027	HT01 027					
	1300	HT01 027	HT01 027	HT01 027	HT01 027	HT01 027	HT01 027	HT01 027	HT01 027			
	1200	HT01 024	HT01 024	HT01 024	HT01 024	HT01 024	HT01 024	HT01 024	HT01 024	HT01 024		
	1100	HT01 024	HT01 024	HT01 024	HT01 024	HT01 024	HT01 024	HT01 024	HT01 024	HT01 024	HT01 024	
		1100	1200	1300	1400	1500	1600	1700	1800	1900	2000	
	GENİŞLİK (mm)											

22-6963	YÜKSEKLİK (mm)	60 kg / m ²										
		1700	HT01 029	HT01 029	HT01 029	HT01 029	HT01 029	HT01 029	HT01 029	HT01 028	HT01 028	HT01 028
		1600	HT01 029	HT01 029	HT01 029	HT01 029	HT01 029	HT01 029	HT01 029	HT01 029	HT01 028	HT01 028
		1500	HT01 029	HT01 029	HT01 029	HT01 029	HT01 029	HT01 029	HT01 029	HT01 029	HT01 028	HT01 028
		1400	HT01 030	HT01 029	HT01 029	HT01 029	HT01 029	HT01 029	HT01 029	HT01 029	HT01 029	HT01 029
		1300	HT01 030	HT01 030	HT01 029	HT01 029	HT01 029	HT01 029	HT01 029	HT01 029	HT01 029	HT01 029
		1200	HT01 030	HT01 030	HT01 030	HT01 029	HT01 029	HT01 029	HT01 029	HT01 029	HT01 029	HT01 029
		1100	HT01 030	HT01 030	HT01 030	HT01 030	HT01 030	HT01 030	HT01 029	HT01 029	HT01 029	HT01 029
		1000	HT01 030	HT01 030	HT01 030	HT01 030	HT01 030	HT01 030	HT01 029	HT01 029	HT01 029	HT01 029
		900	HT01 030	HT01 030	HT01 030	HT01 030	HT01 030	HT01 030	HT01 030	HT01 029	HT01 029	HT01 029
	1100	1200	1300	1400	1500	1600	1700	1800	1900	2000		
	GENİŞLİK (mm)											
YÜKSEKLİK (mm)	96 kg / m ²											
	1500	HT01 028	HT01 028									
	1400	HT01 028	HT01 028	HT01 028								
	1300	HT01 029	HT01 029	HT01 029	HT01 029							
	1200	HT01 029	HT01 029	HT01 029	HT01 029	HT01 029						
	1100	HT01 030	HT01 030	HT01 030	HT01 030	HT01 030	HT01 030					
	1000	HT01 030	HT01 030	HT01 030	HT01 030	HT01 030	HT01 030	HT01 030				
	900	HT01 030	HT01 030	HT01 030	HT01 030	HT01 030	HT01 030	HT01 030	HT01 030	HT01 030		
	800	HT01 030	HT01 030	HT01 030	HT01 030	HT01 030	HT01 030	HT01 030	HT01 030	HT01 030	HT01 030	
		1100	1200	1300	1400	1500	1600	1700	1800	1900	2000	
	GENİŞLİK (mm)											

22-6962	YÜKSEKLİK (mm)	132 kg / m ²										
		2000	HT01 026	HT01 026	HT01 026	HT01 026	HT01 026	HT01 026	HT01 026	HT01 026	HT01 026	HT01 026
		1900	HT01 026	HT01 026	HT01 026	HT01 026	HT01 026	HT01 026	HT01 026	HT01 026	HT01 026	HT01 026
		1800	HT01 026	HT01 026	HT01 026	HT01 026	HT01 026	HT01 026	HT01 026	HT01 026	HT01 026	HT01 026
		1700	HT01 026	HT01 026	HT01 026	HT01 026	HT01 026	HT01 026	HT01 026	HT01 026	HT01 026	HT01 026
		1600	HT01 026	HT01 026	HT01 026	HT01 026	HT01 026	HT01 026	HT01 026	HT01 026	HT01 026	HT01 026
	1100	1200	1300	1400	1500	1600	1700	1800	1900	2000		
	GENİŞLİK (mm)											



FLS 100

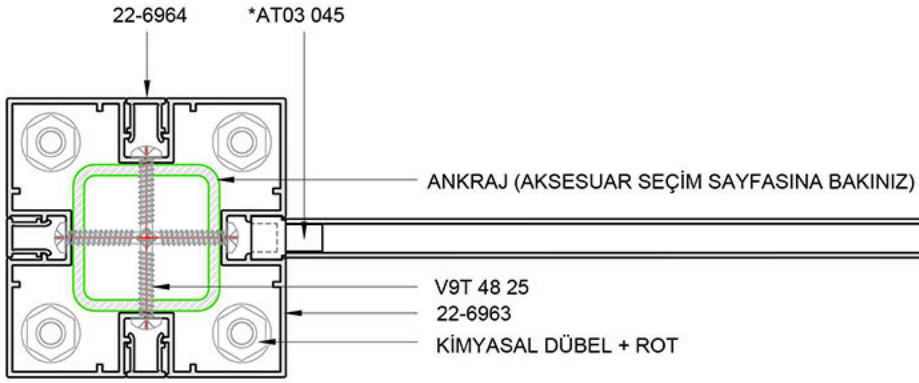

*AT 03 0
ALTERNATİF K

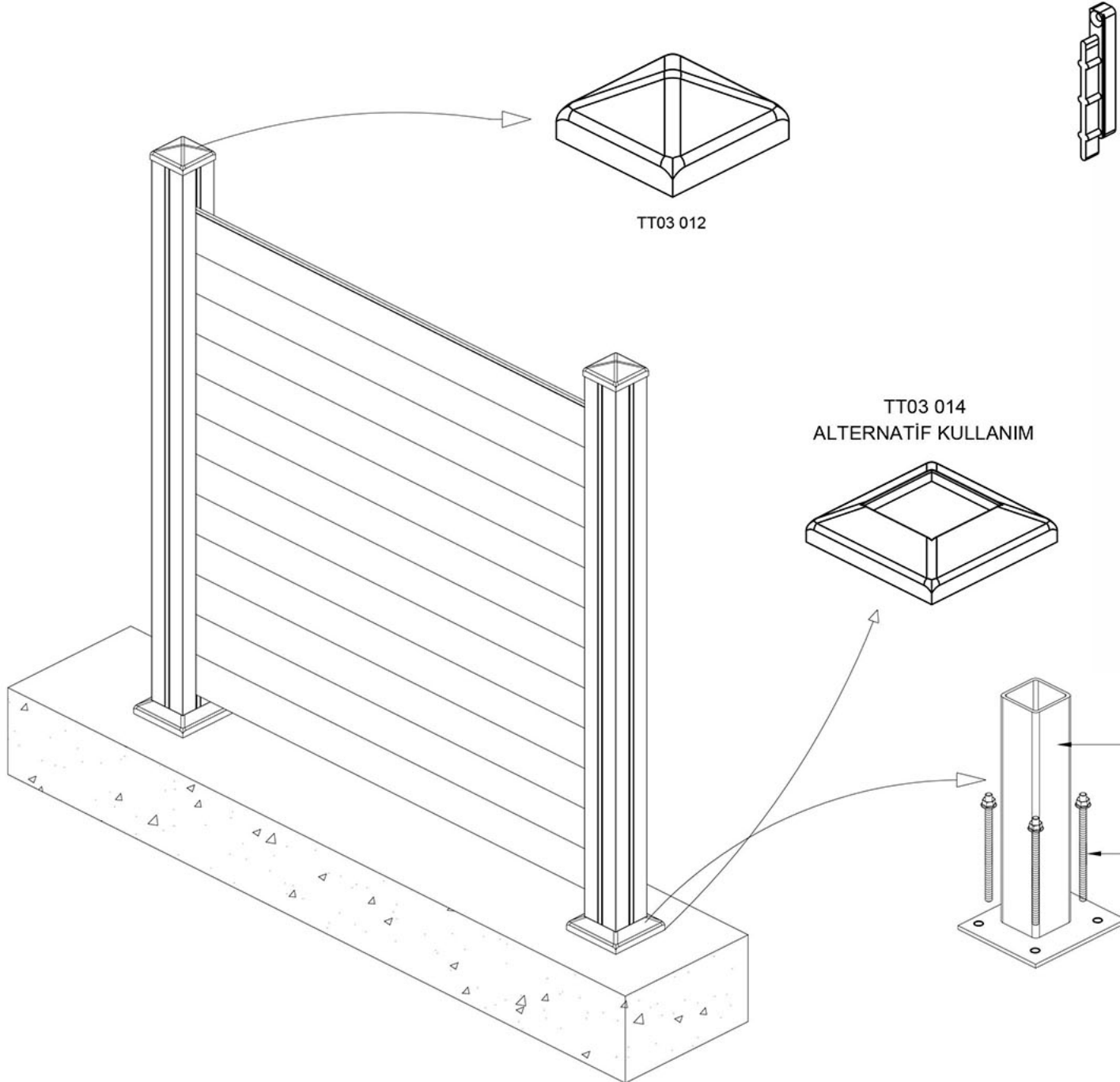

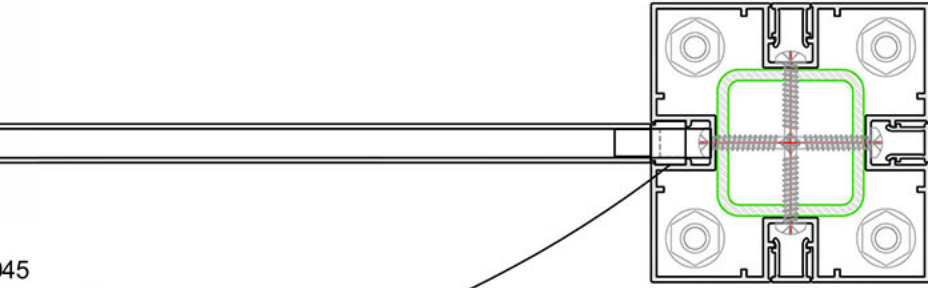

45
KULLANIM

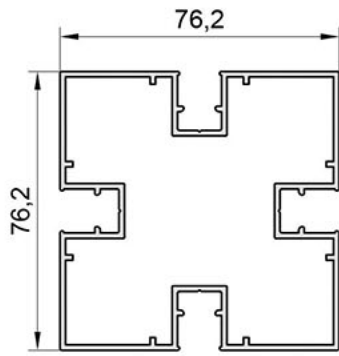

22-6963



99-1209



22-6964



00-1362

ANKRAJ

KİMYASAL DÜBEL + ROT

Ölçek 1/2

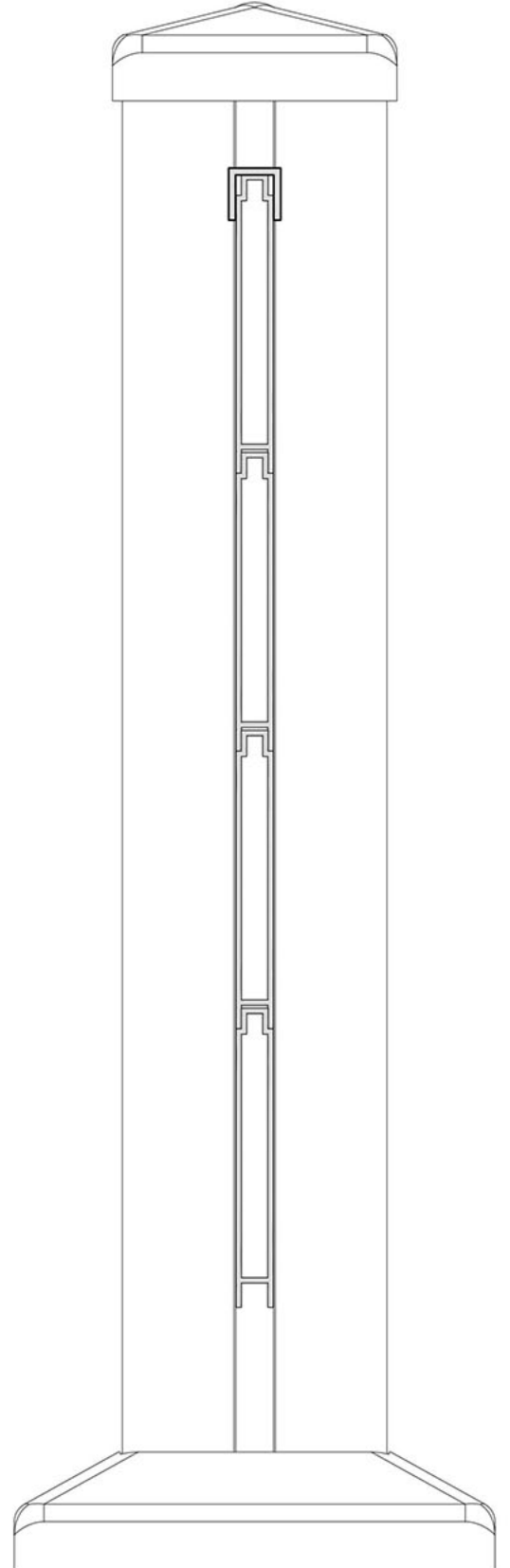

FLS 100

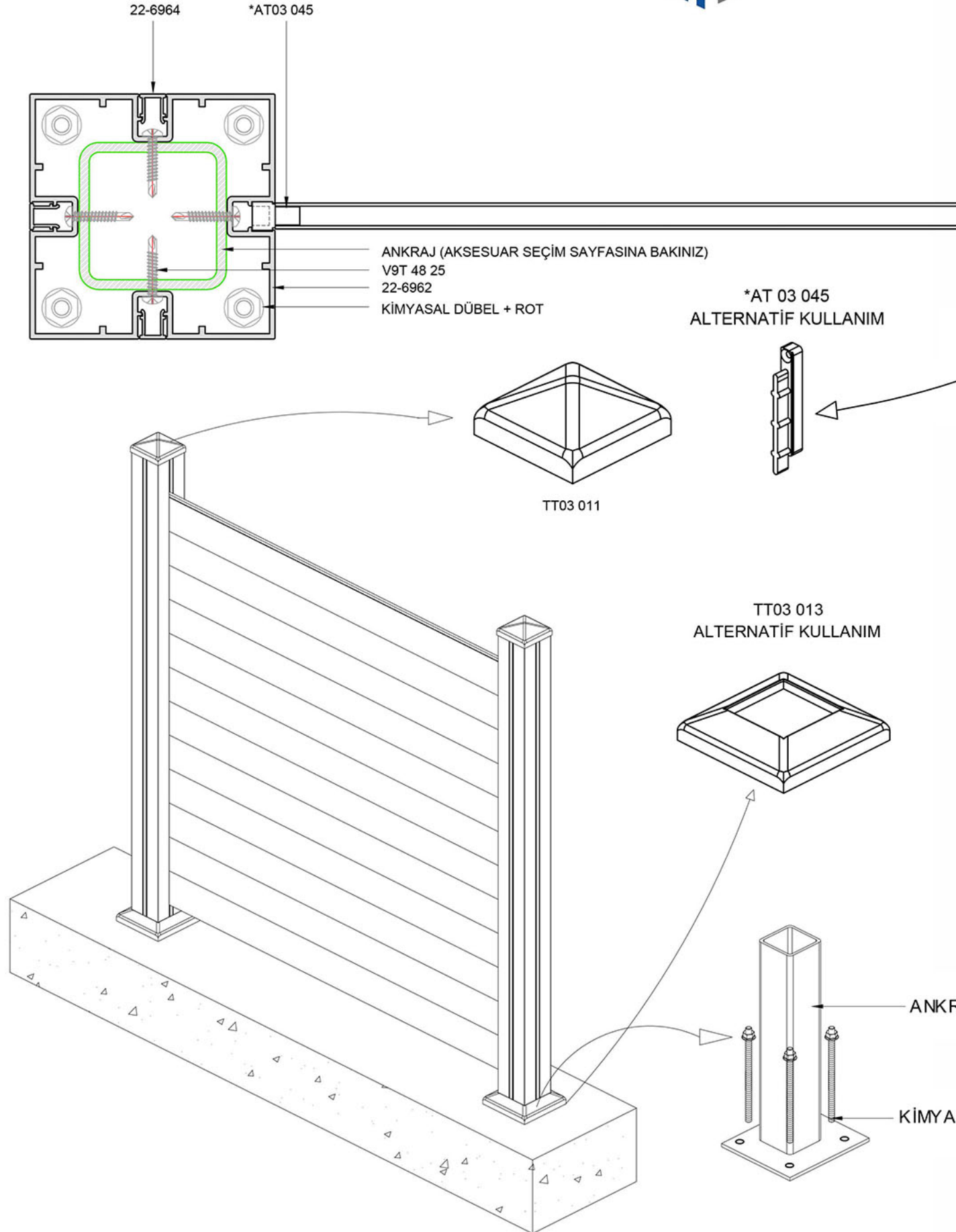

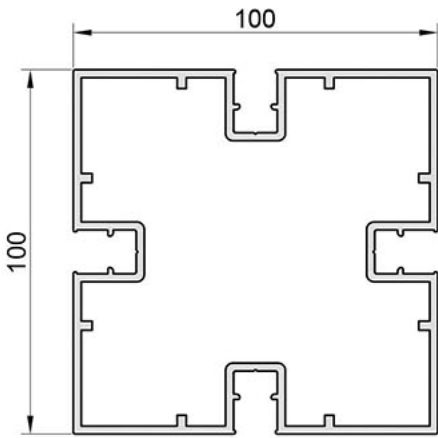
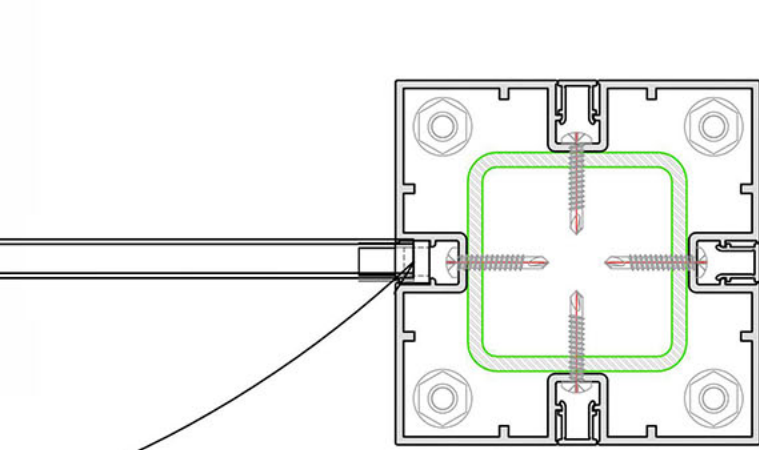

22-6962



99-1209



22-6964



00-1362

Ölçek 1/2

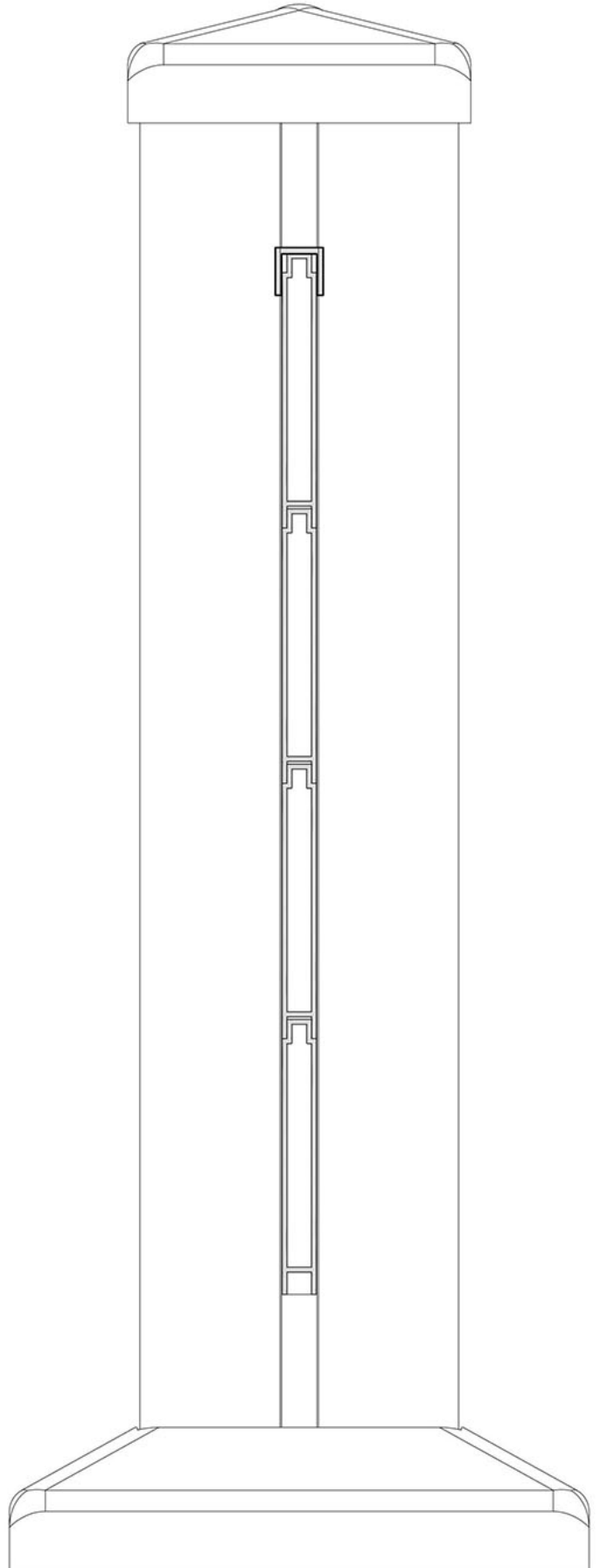

RAJ

SAL DÜBEL + ROT

FLS 100

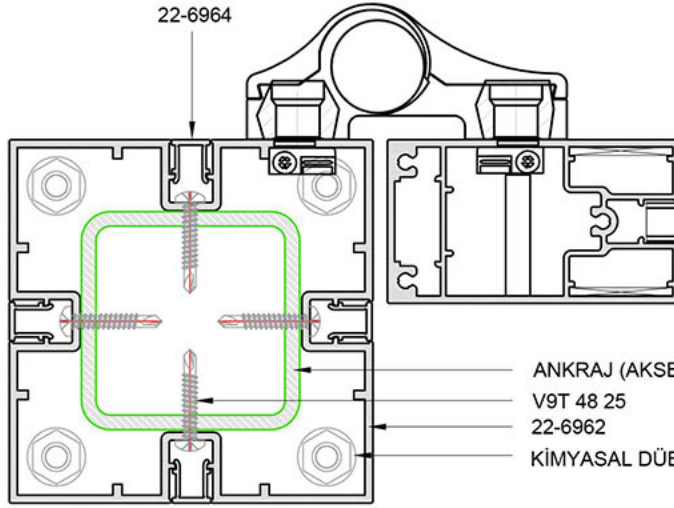

- ANKRAJ (AKSESUAR SEÇİM SAYFASINA BAKINIZ)
- V9T 48 25
- 22-6962
- KİMYASAL DÜBEL + ROT

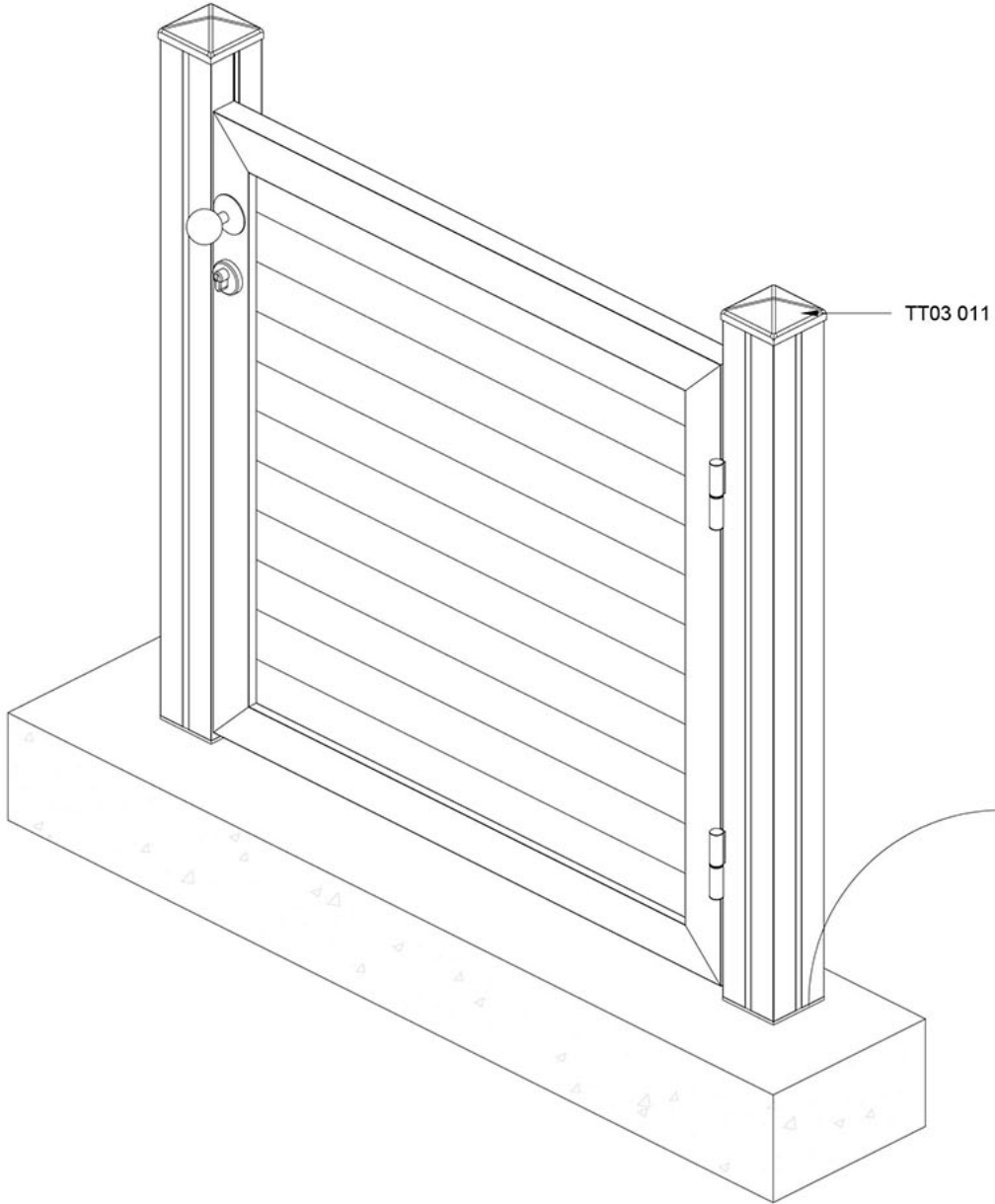

ANKRAJ

KİMYASAL DÜBEL

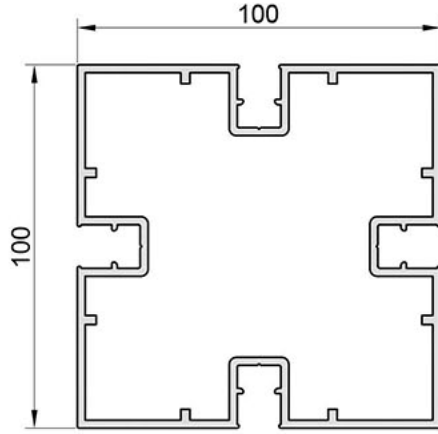
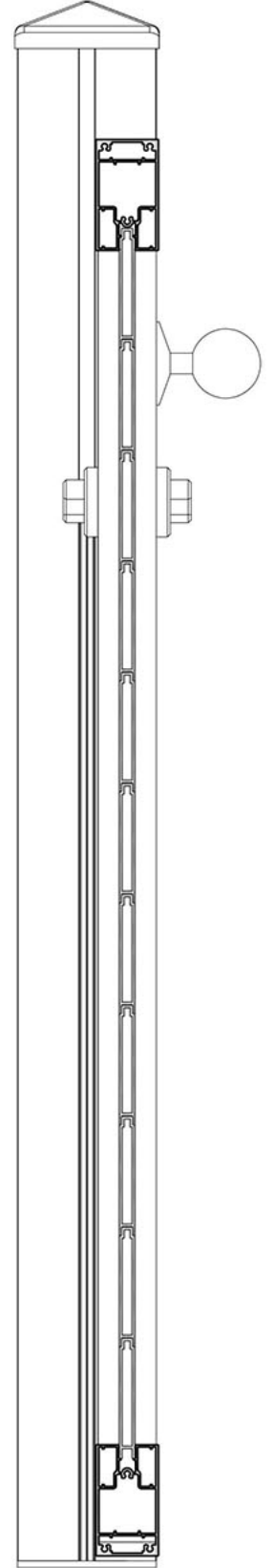
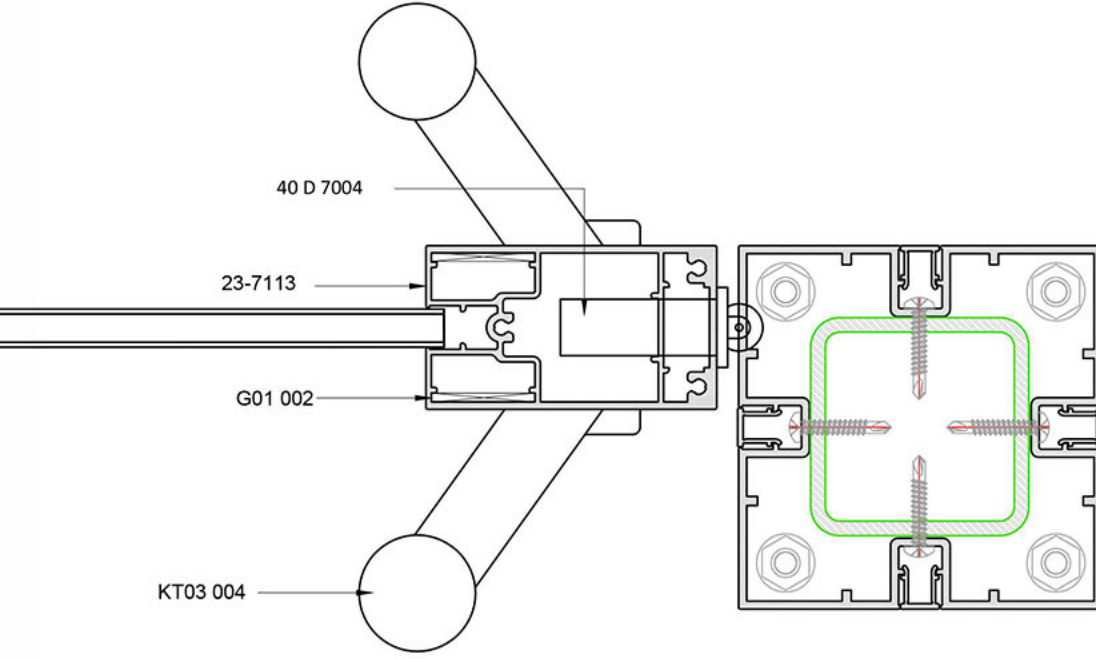

22-6962

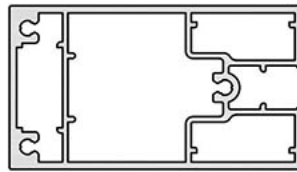

23-7113



99-1209



92-446



22-6964

SAL DÜBEL + ROT

Ölçek 1/2

FLS 100

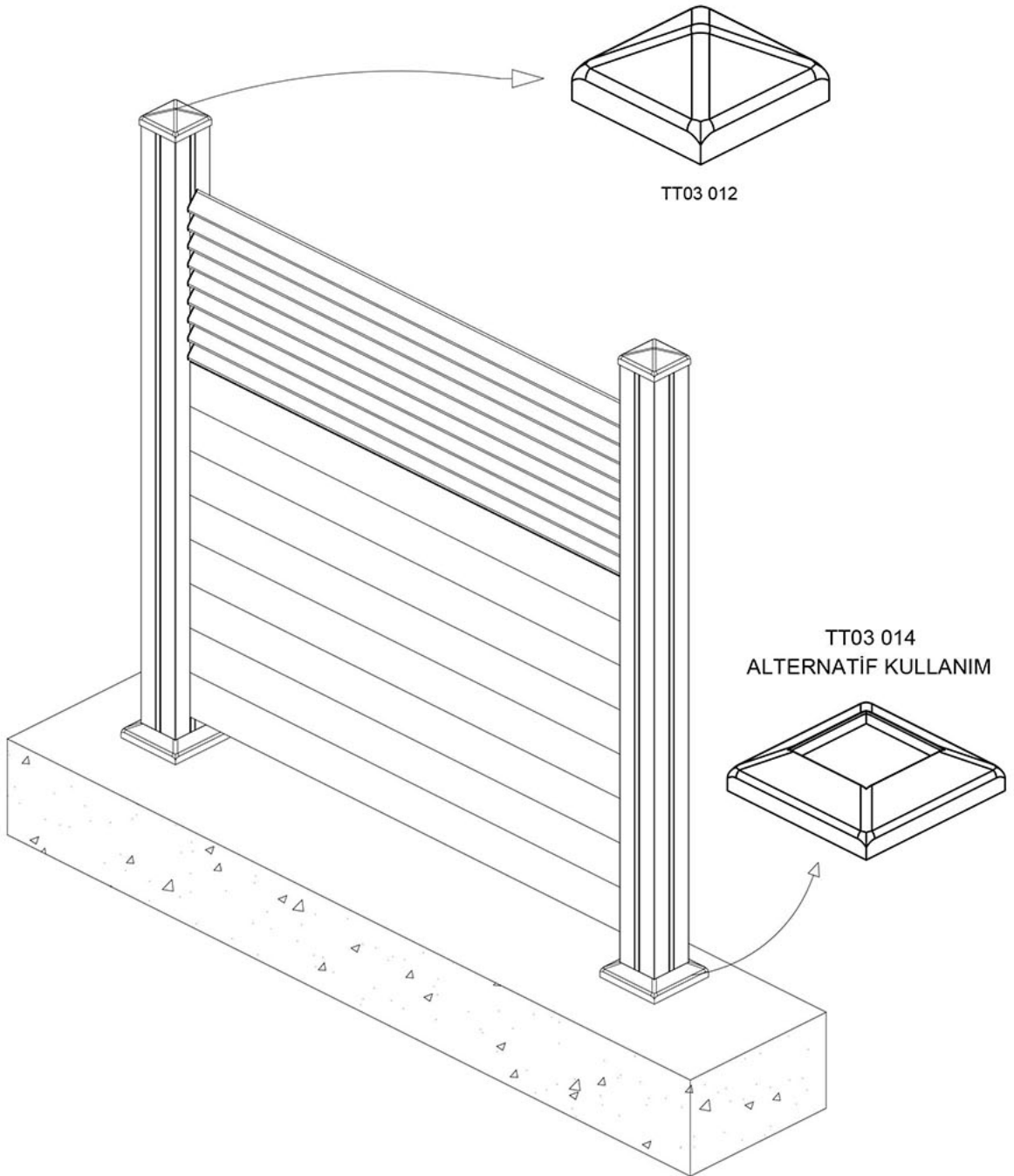
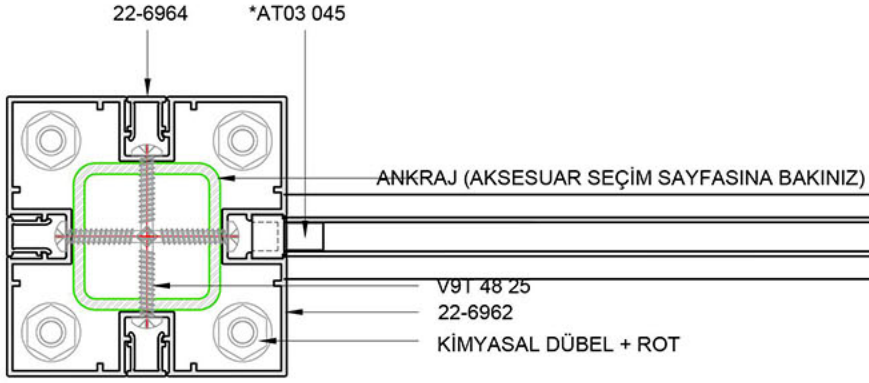

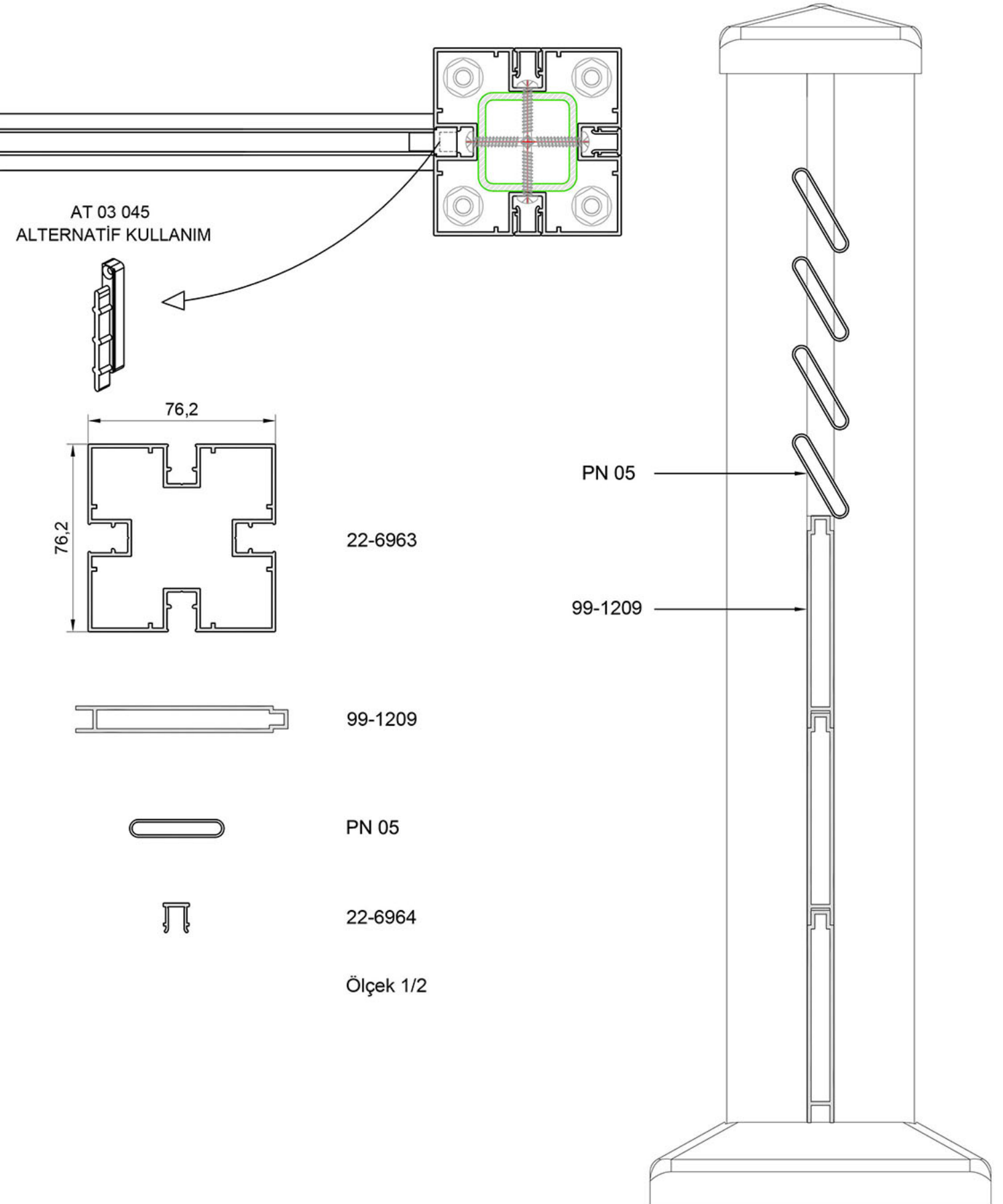

FLS 100

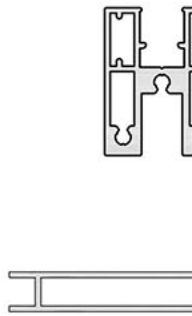
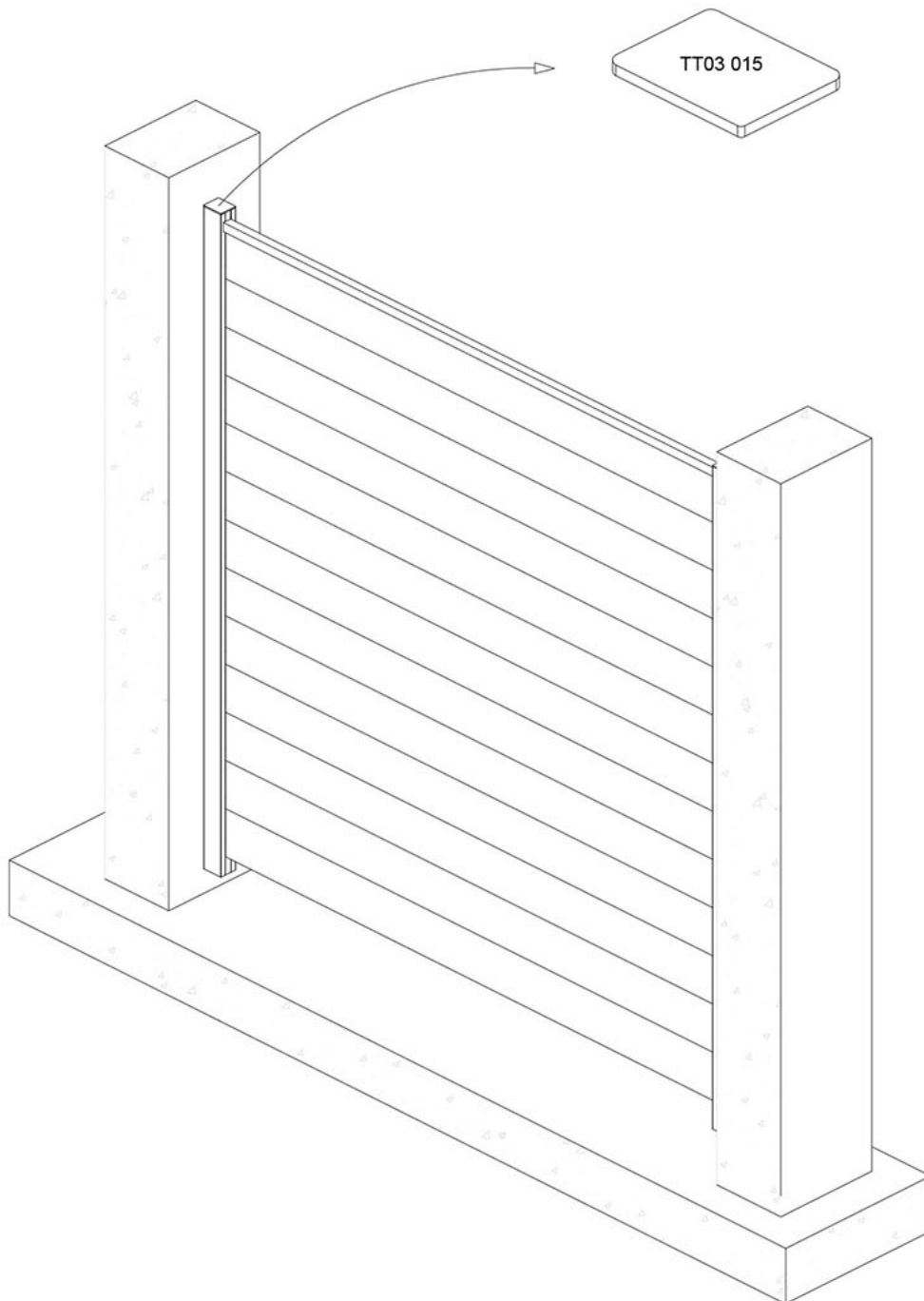
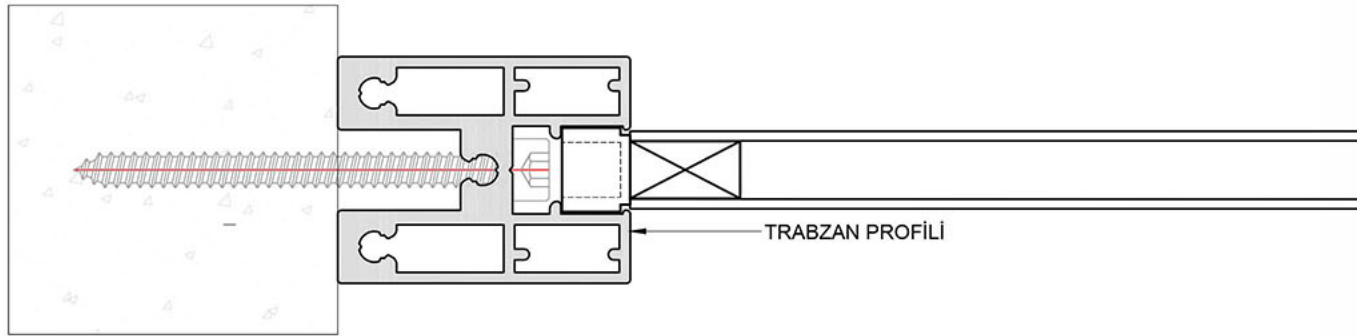

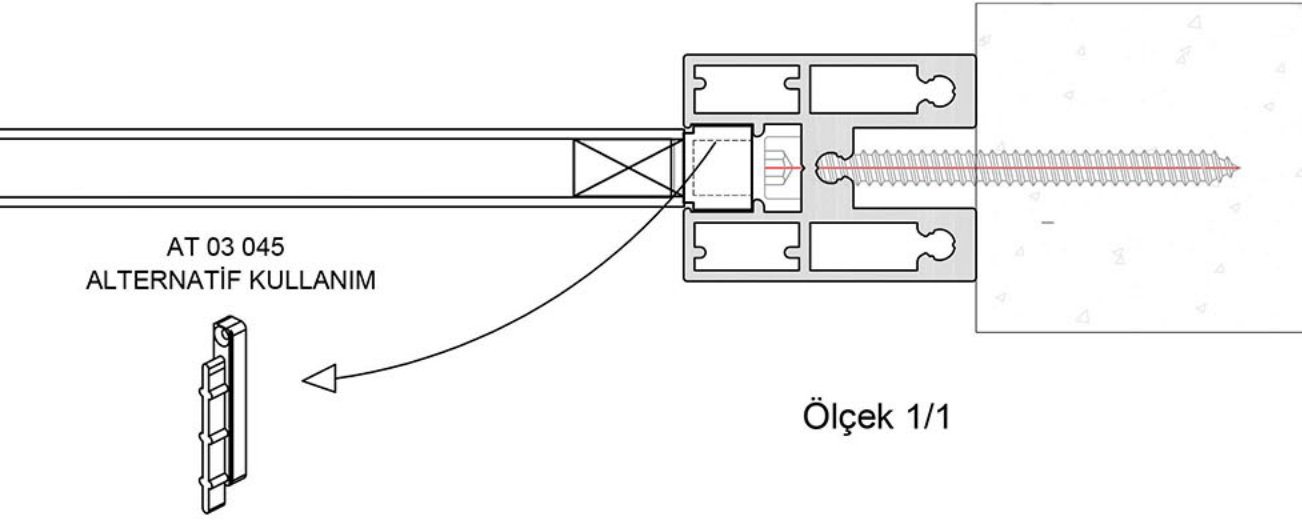

23-7140



99-1209

Ölçek 1/2

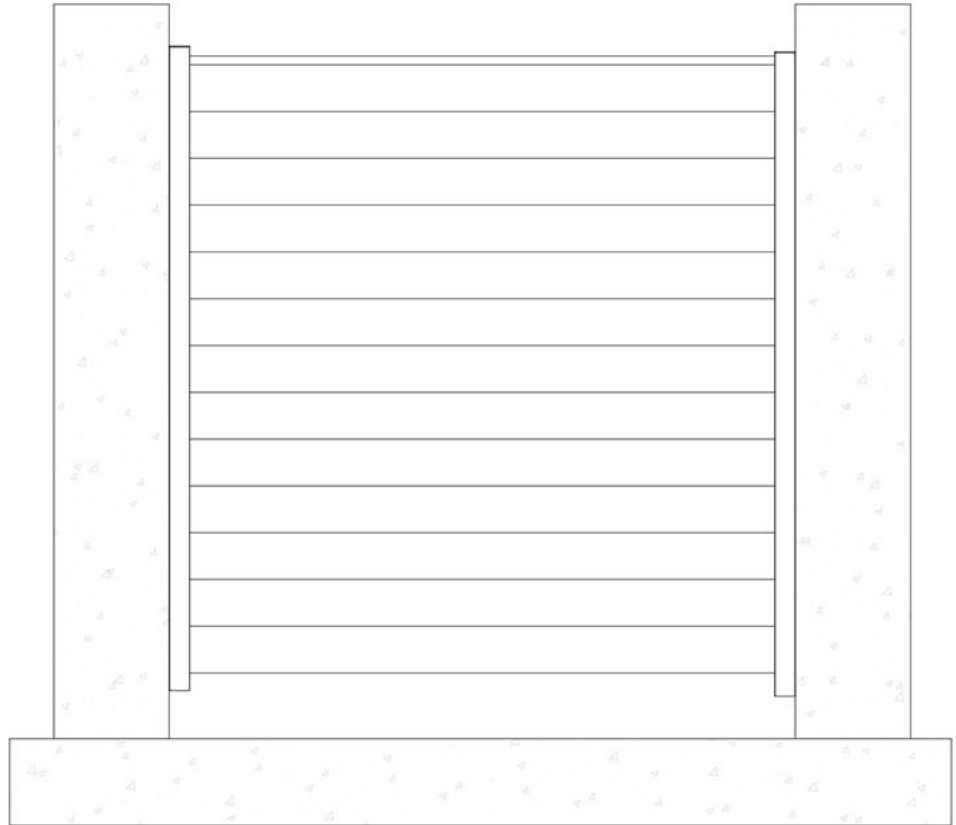

FLS 100

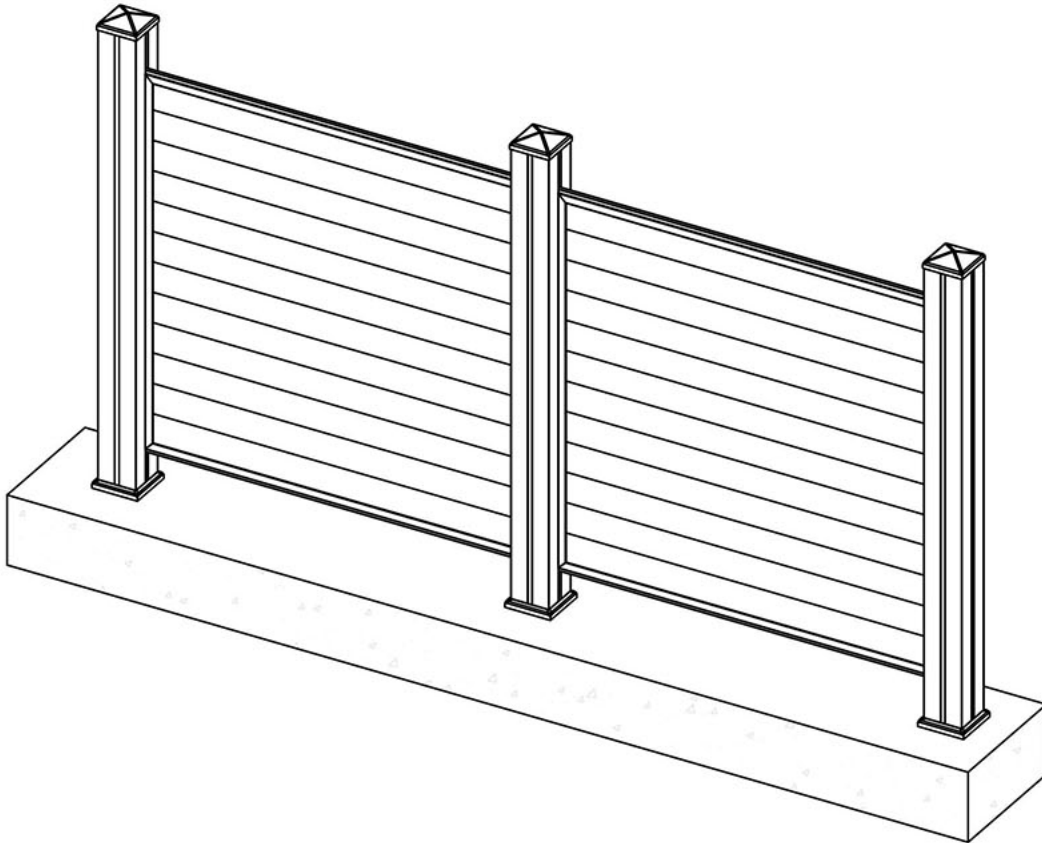
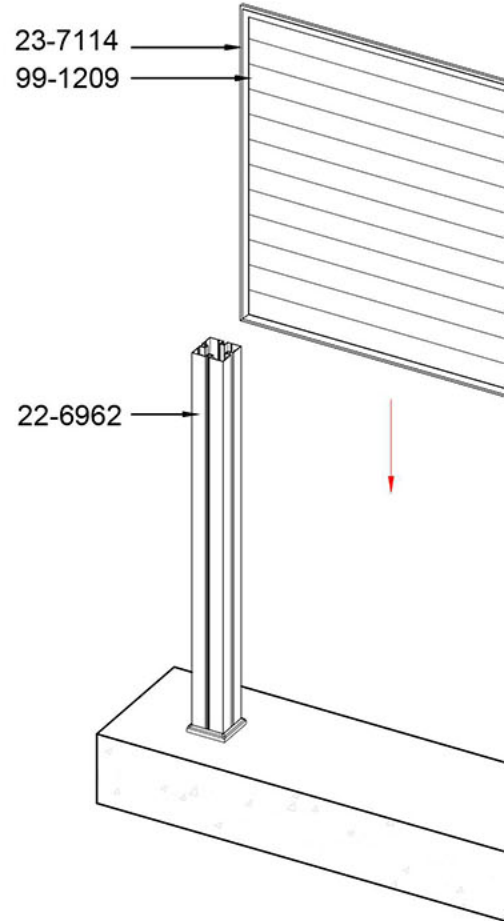
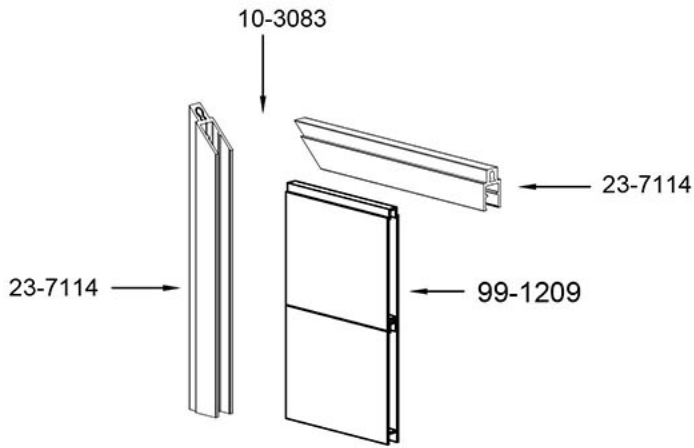
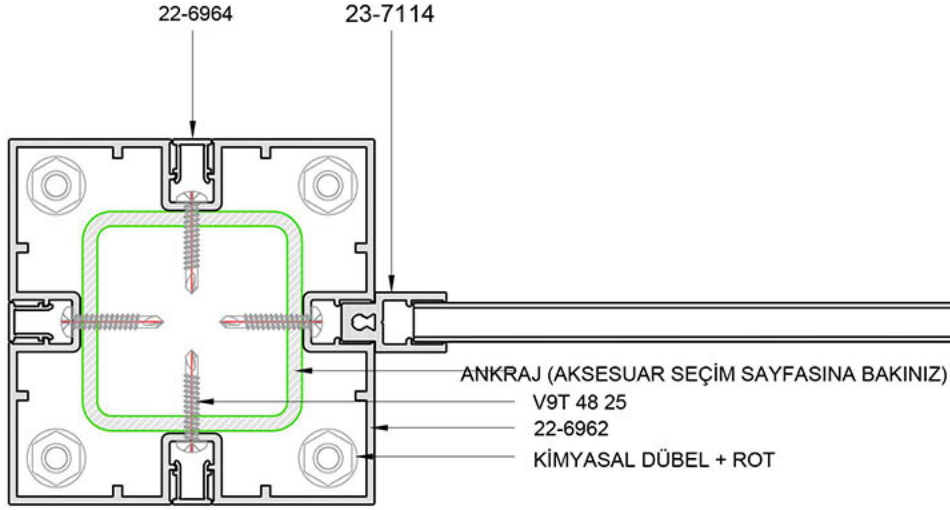

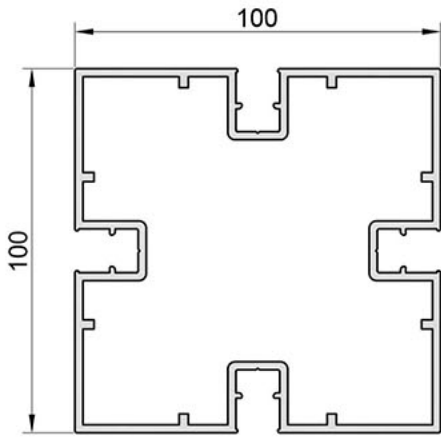
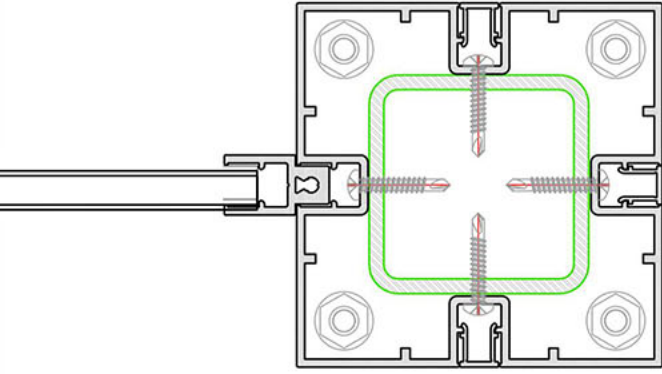

22-6962



99-1209

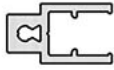

23-7114



22-6964

Ölçek 1/2

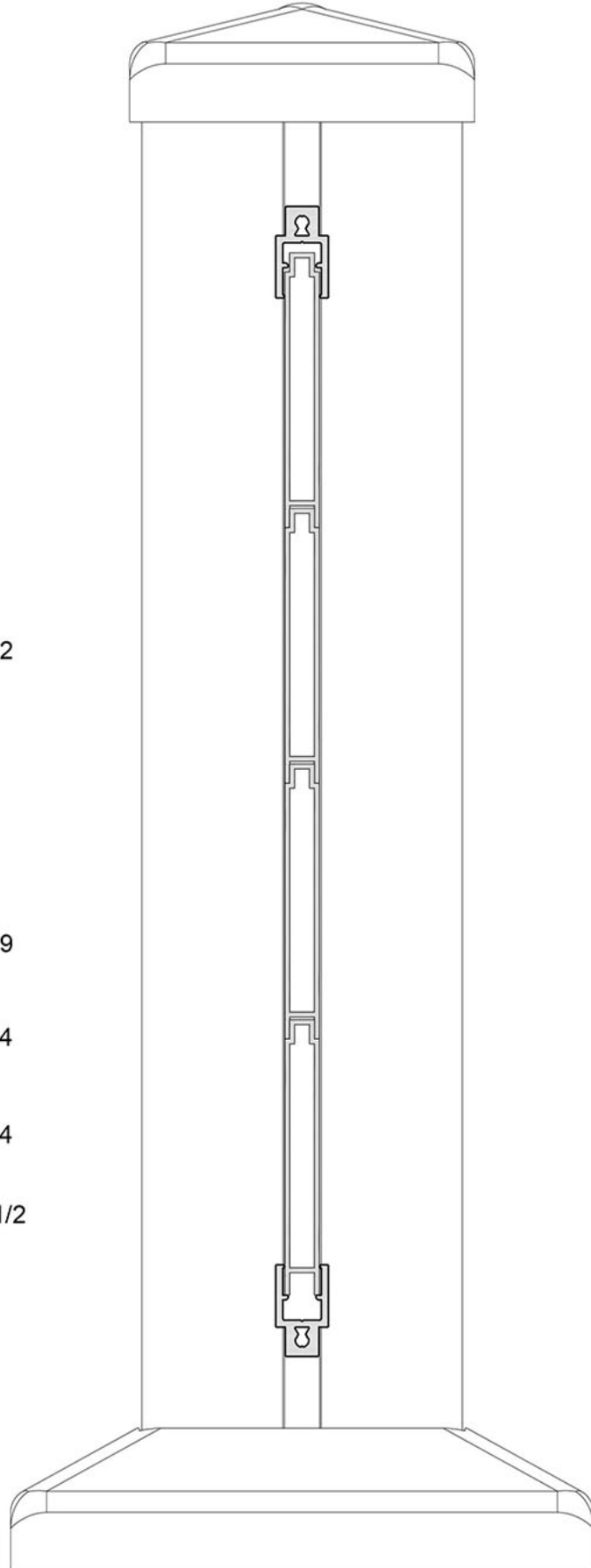

FLS 100

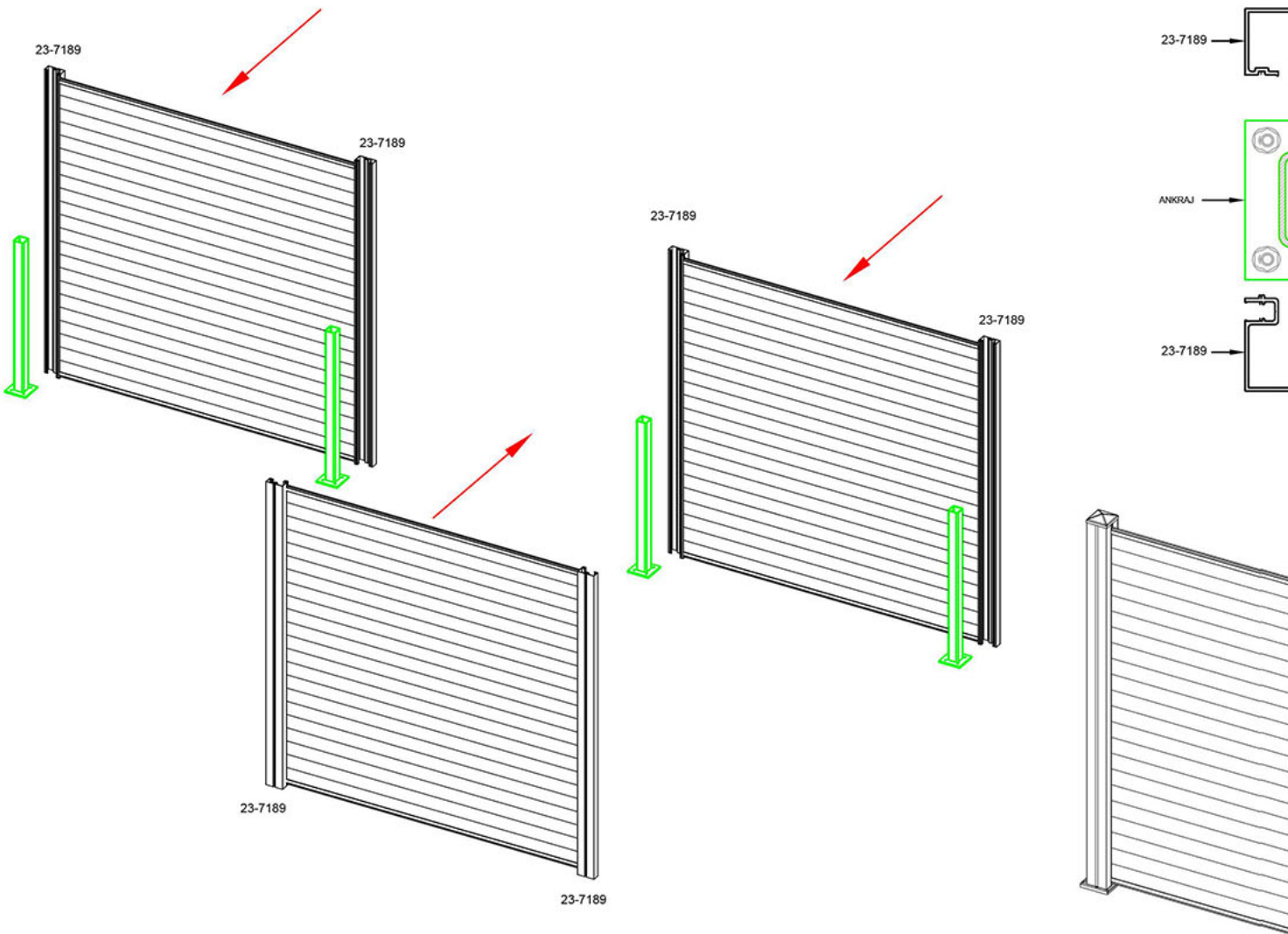
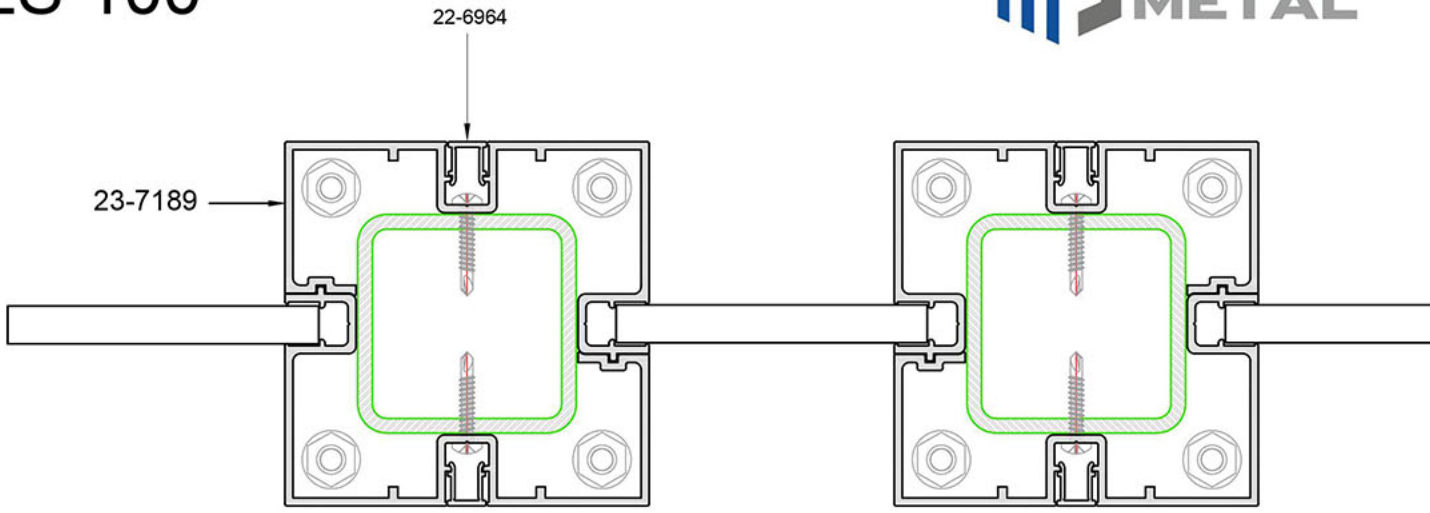

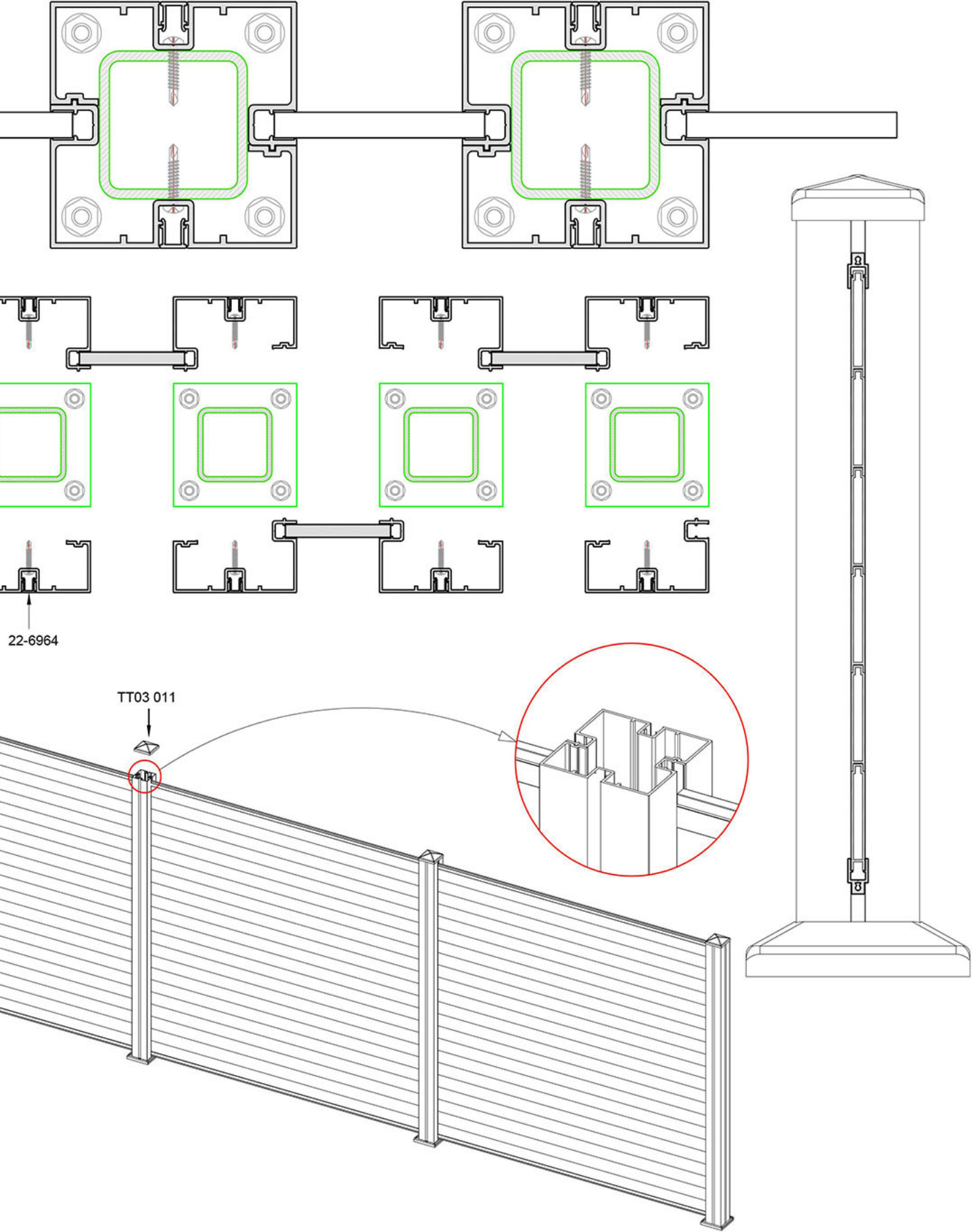

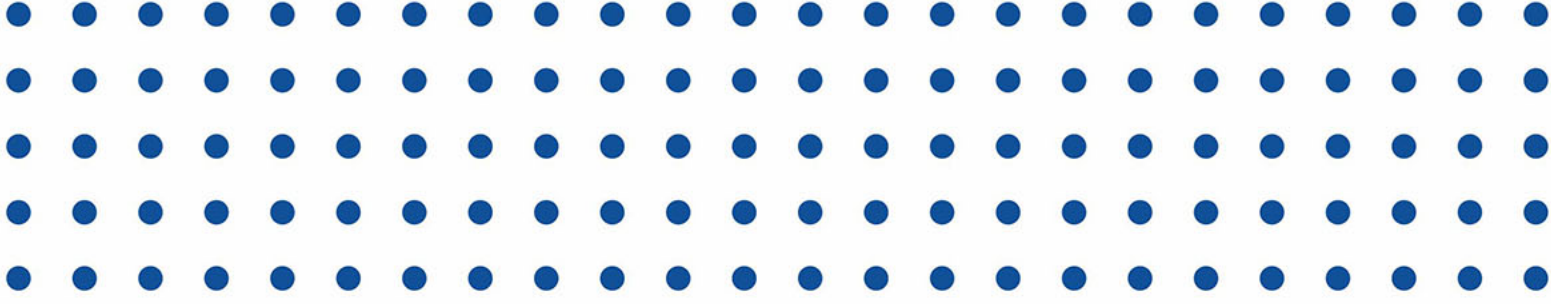

Front Trade Metal Sanayi Ltd.Şti.
Barbaros Hayrettin Paşa Mah. 1995 Sk. No: 1/3
AKROS K:26 D:445 34522 Esenyurt / İstanbul / TÜRKİYE
Gsm: +90 543 189 23 23
E-mail: sales@frontmetal.com.tr

www.frontmetal.com.tr